

# 2SA1488/1488A

Silicon PNP Epitaxial Planar Transistor (Complement to type 2SC3851/A)

Application : Audio and General Purpose

**Absolute maximum ratings** (Ta=25°C)

Symbol	2SA1488	2SA1488A	Unit
V <sub>CBO</sub>	-60	-80	V
V <sub>CEO</sub>	-60	-80	V
V <sub>EB0</sub>	-6		V
I <sub>C</sub>	-4		A
I <sub>B</sub>	-1		A
P <sub>C</sub>	25(T <sub>C</sub> =25°C)		W
T <sub>J</sub>	150		°C
T <sub>stg</sub>	-55 to +150		°C

**Electrical Characteristics** (Ta=25°C)

Symbol	Conditions	2SA1488	2SA1488A	Unit
I <sub>CBO</sub>	V <sub>CB</sub> =	-100max	-100max	μA
V <sub>CEO</sub>	I <sub>C</sub> =-25mA	-60min	-80min	V
I <sub>EB0</sub>	V <sub>EB</sub> =-6V		-100max	μA
V <sub>(BR)CEO</sub>	I <sub>C</sub> =-2A, I <sub>B</sub> =-0.2A		-0.5max	V
h <sub>FE</sub>	V <sub>CE</sub> =-4V, I <sub>C</sub> =-1A		40min	
f <sub>T</sub>	V <sub>CE</sub> =-12V, I <sub>E</sub> =0.2A		15typ	MHz
C <sub>OB</sub>	V <sub>CB</sub> =-10V, f=1MHz		90typ	pF

**External Dimensions FM20 (TO220F)**

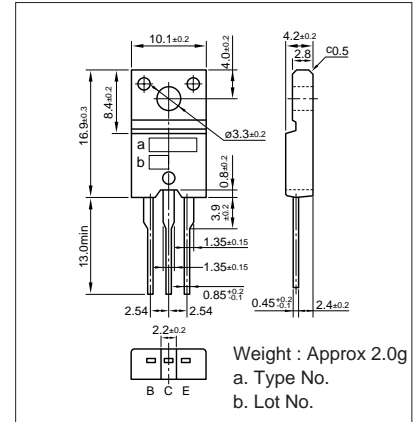

**Typical Switching Characteristics (Common Emitter)**

V <sub>CC</sub> (V)	R <sub>L</sub> (Ω)	I <sub>C</sub> (A)	V <sub>BB1</sub> (V)	V <sub>BB2</sub> (V)	I <sub>B1</sub> (mA)	I <sub>B2</sub> (mA)	t <sub>on</sub> (μs)	t <sub>stg</sub> (μs)	t <sub>f</sub> (μs)
-12	6	-2	-10	5	-200	200	0.25typ	0.75typ	0.25typ

**I<sub>C</sub>-V<sub>CE</sub> Characteristics (Typical)**

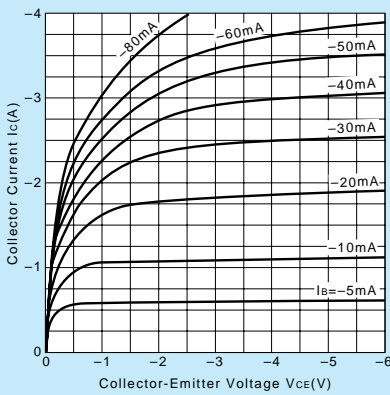

**V<sub>CE(sat)</sub>-I<sub>B</sub> Characteristics (Typical)**

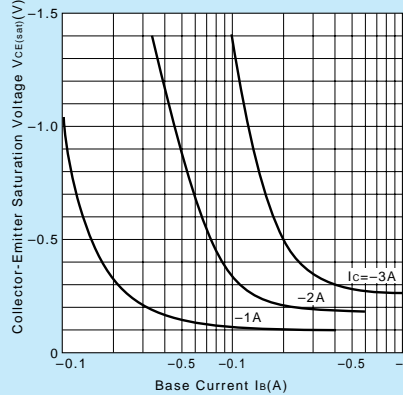

**I<sub>C</sub>-V<sub>BE</sub> Temperature Characteristics (Typical)**

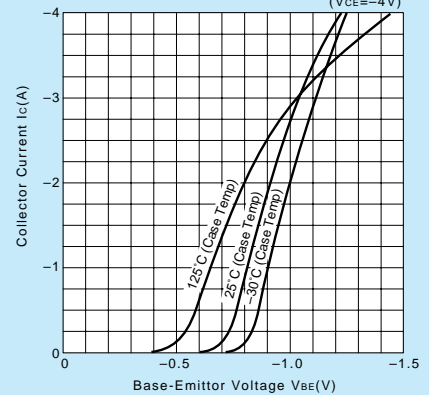

**h<sub>FE</sub>-I<sub>C</sub> Characteristics (Typical)**

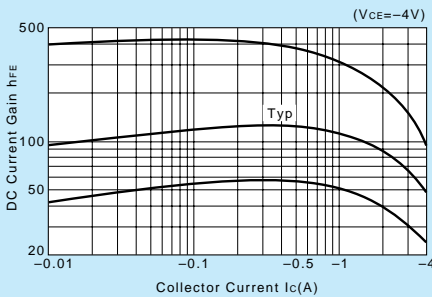

**h<sub>FE</sub>-I<sub>C</sub> Temperature Characteristics (Typical)**

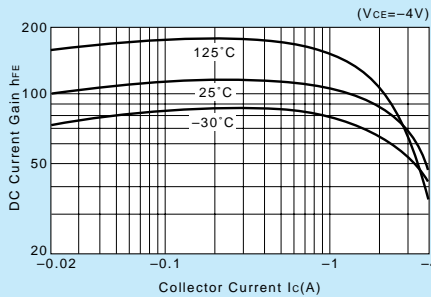

**θ<sub>j-a</sub>-t Characteristics**

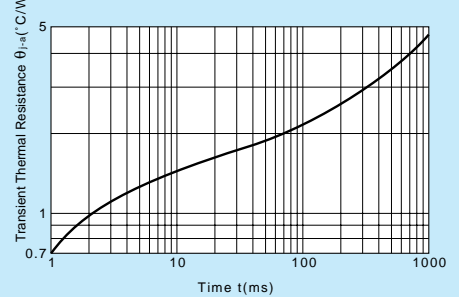

**f<sub>T</sub>-I<sub>E</sub> Characteristics (Typical)**

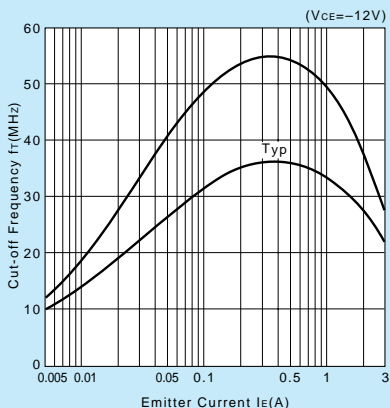

**Safe Operating Area (Single Pulse)**

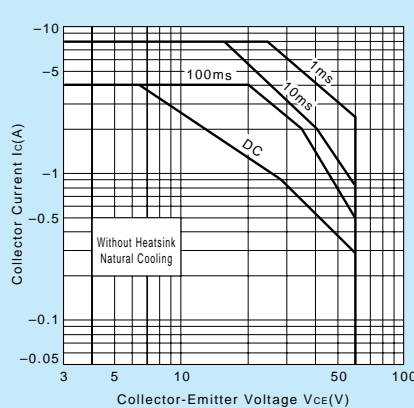

**P<sub>C</sub>-T<sub>a</sub> Derating**

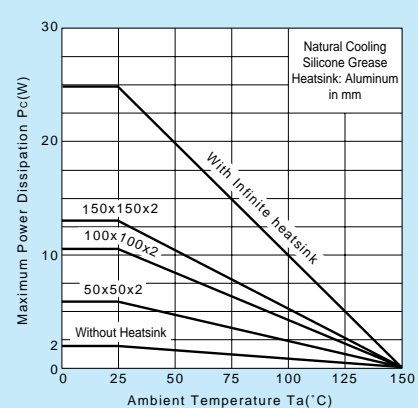

This datasheet has been download from:

[www.datasheetcatalog.com](http://www.datasheetcatalog.com)

Datasheets for electronics components.